

56 Sparta Avenue • Newton, New Jersey 07860
 (973) 300-3000 Sales • (973) 300-3600 Fax
 www.thorlabs.com



BF-915-0180 - January 6, 2015

Item # BF-915-0180 was discontinued on January 6, 2015. For informational purposes, this is a copy of the website content at that time and is valid only for the stated product.

FABRY-PEROT LASER DIODES, PIGTAILED BUTTERFLY PACKAGE

- ▶ Integrated TEC Element
- ▶ FC/APC Terminated
- ▶ Central Wavelength Between 785 nm and 2000 nm

Application Idea
 Laser Diode with
 CLD1015 Mount



FPL785S-250
 785 nm Laser Diode
 Single Mode Fiber



FPL1059P
 1650 nm Laser
 Diode
 PM Fiber



[Hide Overview](#)

OVERVIEW

Features

- Center Wavelengths from 785 nm to 2 μ m
- FC/APC Connectors (2.0 mm Narrow Key) with SM or PM Fiber
- Integrated TEC Element
- 14 Pin, Type 1 Butterfly Package

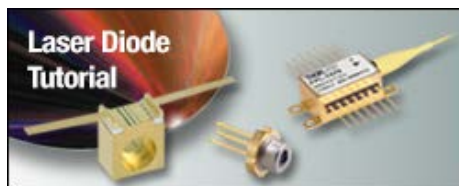

These laser diodes are housed in a type 1, 14-pin butterfly package. All laser diodes include fiber pigtails of either 1, 1.5 or 3 m in length, terminated with FC/APC connectors (2.0 mm narrow key). Each butterfly package laser diode includes a data sheet with operating data for the particular unit. For information on customizing butterfly-packaged laser diodes, please contact Technical Support.

Laser Diode Selection Guide

Shop by Wavelength	UV (375 nm)
	Visible (404 nm - 690 nm) NIR (705 nm - 2000 nm) MIR (3.42 μ m - 9.60 μ m)
Shop by Package/Type	TO Can (\varnothing 5.6, \varnothing 9, and \varnothing 9.5 mm) TO Can Pigtail (SM) TO Can Pigtail (PM) TO Can Pigtail (MM) FP Butterfly Package FBG-Stabilized Butterfly Package Chip on Submount MIR Fabry-Perot Two-Tab C-Mount One-Tab C-Mount
	Single Frequency Lasers
	DFB Single-Frequency TO Can Pigtail (SM) VHG-Stabilized Single-Frequency ECL Single-Frequency Butterfly Package DBR Single-Frequency Butterfly Package MIR DFB Two-Tab C-Mount



While the center wavelength is listed for each laser diode, this is only a typical number. The center wavelength of a particular unit varies from production run to production run, so the diode you receive may not operate at the typical center wavelength. Diodes can be temperature tuned, which will alter the lasing wavelength. The FPL785S-250 laser diode is available as a serialized item. After clicking "Choose Item" below, a list will appear that contains the dominant wavelength, output power, and operating current of each in-stock unit. Clicking on the red Docs Icon next to the serial number provides access to a PDF with serial-number-specific L-I-V and spectral characteristics.

Laser diodes are sensitive to electrostatic shock. Please take the proper precautions when handling the device, such as using an ESD wrist strap. For warranty information and the Thorlabs Life Support and Military Use Policy for laser diodes, please refer to the *LD Operation* tab.

We recommend cleaning the fiber connector before each use if there is any chance that dust or other contaminants may have deposited on the surface. The laser intensity at the center of the fiber tip can be very high and may burn the tip of the fiber if contaminants are present. While the connectors on these pigtailed laser diodes are cleaned and capped before shipping, we cannot guarantee that they will remain free of contamination after they are removed from the package. A selection of fiber cleaning supplies is available here. For all of these pigtailed laser diodes, the laser must be off when connecting or disconnecting the device from other fibers, particularly at power levels above 10 mW.

Mount and Driver Options

These butterfly packages are compatible with the CLD1015 laser diode mount with integrated controller and TEC. They are also compatible with the LM14S2 mount and ITC4001 LD/TEC controller, or the LDC1300B Laser Diode Controller, which contains an integrated TEC controller and is controlled by a PC via an RS-232 interface.

Webpage Features	
	Clicking this icon below will open a window that contains item specific specifications and mechanical drawings.
	Clicking this docs icon next to the item number (e.g., LP808-SF30) will allow you to download our standard support documentation. In addition, after clicking "Choose Item" below, clicking the docs icon next to the serial number (e.g., 120810-51) will allow you to view unit-specific L-I-V and spectral measurements.

[Hide Pin Diagram](#)

PIN DIAGRAM

Type 1 Butterfly Package Pin Diagram

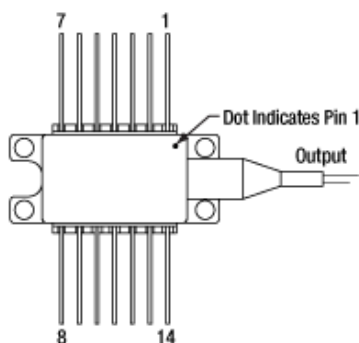

Pin Identification			
Pin	Assignment	Pin	Assignment
1	TEC +	14	TEC -
2	Thermistor	13	Case
3	PD Anode (Select Models Only)	12	-
4	PD Cathode (Select Models Only)	11	LD Cathode
5	Thermistor	10	LD Anode
6	-	9	-
7	-	8	-

[Hide LD Operation](#)

LD OPERATION

Laser Diode and Laser Diode Pigtail Warranty

When operated within their specifications, laser diodes have extremely long lifetimes. Most failures occur from mishandling or operating the lasers beyond their maximum ratings. Laser Diodes are among the most static-sensitive devices currently made. Proper ESD Protection should be worn whenever handling a laser diode. Due to their extreme electrostatic sensitivity, laser diodes cannot be returned after their sealed package has been open. Laser diodes in their original sealed package can be returned for a full refund or credit.

Handling and Storage Precautions

Due to their extreme susceptibility to damage from electrostatic discharge (ESD), care should be taken whenever handling and operating laser diodes:

- Wrist Straps: Use grounded anti-static wrist straps whenever handling diodes.
- Anti-Static Mats: Always work on grounded anti-static mats.
- Laser Diode Storage: When not in use, short the leads of the laser together to protect against ESD damage.

Operating and Safety Precautions

Use an Appropriate Driver:

Laser diodes require precise control of operating current and voltage to avoid overdriving the laser diode. In addition, the laser driver should provide protection against power supply transients. Select a laser driver appropriate for your application. Do not use a voltage supply with a current limiting resistor since it does not provide sufficient regulation to protect the laser.

Power Meters:

When setting up and calibrating a laser diode with its driver, use a NIST-traceable power meter to precisely measure the laser output. It is usually safest to measure the laser output directly before placing the laser in an optical system. If this is not possible, be sure to take all optical losses (transmissive, aperture stopping, etc.) into consideration when determining the total output of the laser.

Reflections:

Flat surfaces in the optical system in front of a laser diode can cause some of the laser energy to reflect back onto the laser's monitor photodiode giving an erroneously high photodiode current. If optical components are moved within the system and energy is no longer reflected onto the monitor photodiode, a constant power feedback loop will sense the drop in photodiode current and try to compensate by increasing the laser drive current and possibly overdriving the laser. Back reflections can also cause other malfunctions or damage to laser diodes. To avoid this, be sure that all surfaces are angled 5-10°, and when necessary, use optical isolators to attenuate direct feedback into the laser.

Heat Sinks:

Laser diode lifetime is inversely proportional to operating temperature. Always mount the laser in a suitable heat sink to remove excess heat from the laser package.

Voltage and Current Overdrive:

Be careful not to exceed the maximum voltage and drive current listed on the specification sheet with each laser diode, even momentarily. Also, reverse voltages as little as 3 V can damage a laser diode.

ESD Sensitive Device:

Currently operating lasers are susceptible to ESD damage. This is particularly aggravated by using long interface cables between the laser diode and its driver due to the inductance that the cable presents. Avoid exposing the laser or its mounting apparatus to ESDs at all times.

ON/OFF and Power Supply Coupled Transients:

Due to their fast response times, laser diodes can be easily damaged by transients less than 1 μ s. High current devices such as soldering irons, vacuum pumps, and fluorescent lamps can cause large momentary transients. Thus, always use surge-protected outlets.

If you have any questions regarding laser diodes, please call your local Thorlabs Technical Support office for assistance.

Life Support and Military Use Application Policy

Thorlabs' products are not authorized for use as critical components in life support devices or systems or in any military applications without the express written approval of the president of Thorlabs:

1. Life support devices or systems are devices or systems intended for either surgical implantation into the body or to sustain life and whose failure to perform, when properly used in accordance with instructions for use provided in the labeling, can be reasonably expected to result in a significant injury to the user.
2. A critical component is any component in a life support device or system whose failure to perform can be reasonably expected to cause the failure of the life support device or system or to affect its safety or effectiveness.
3. Thorlabs' laser diodes are not intended nor warranted for usage in Military Applications.

[Hide Laser Safety](#)

L A S E R S A F E T Y**Laser Safety and Classification**

Safe practices and proper usage of safety equipment should be taken into consideration when operating lasers. The eye is susceptible to injury, even from very low levels of laser light. Thorlabs offers a range of laser safety accessories that can be used to reduce the risk of accidents or injuries. Laser emission in the visible and near infrared spectral ranges has the greatest potential for retinal injury, as the cornea and lens are transparent to those wavelengths, and the lens can focus the laser energy onto the retina.

Safe Practices and Light Safety Accessories

- Thorlabs recommends the use of safety eyewear whenever working with laser beams with non-negligible powers (i.e., > Class 1) since metallic tools such as screwdrivers can accidentally redirect a beam.
- Laser goggles designed for specific wavelengths should be clearly available near laser setups to protect the wearer from unintentional laser reflections.
- Goggles are marked with the wavelength range over which protection is afforded and the minimum optical density within that range.
- Laser Barriers and Blackout Materials can prevent direct or reflected light from leaving the experimental setup area.
- Thorlabs' Enclosure Systems can be used to contain optical setups to isolate or minimize laser hazards.
- A fiber-pigtailed laser should always be turned off before connecting it to or disconnecting it from another fiber, especially when the laser is at power levels above 10 mW.
- All beams should be terminated at the edge of the table, and laboratory doors should be closed whenever a laser is in use.
- Do not place laser beams at eye level.
- Carry out experiments on an optical table such that all laser beams travel horizontally.
- Remove unnecessary reflective items such as reflective jewelry (e.g., rings, watches, etc.) while working near the beam path.
- Be aware that lenses and other optical devices may reflect a portion of the incident beam from the front or rear surface.
- Operate a laser at the minimum power necessary for any operation.
- If possible, reduce the output power of a laser during alignment procedures.
- Use beam shutters and filters to reduce the beam power.
- Post appropriate warning signs or labels near laser setups or rooms.











Use laser sign lightboxes if operating Class 3R or 4 lasers (i.e., lasers requiring the use of a safety interlock).

- Do not use Laser Viewing Cards in place of a proper Laser Barrier or Beam Trap.

Laser Classification







Lasers are categorized into different classes according to their ability to cause eye and other damage. The International Electrotechnical Commission (IEC) is a global organization that prepares and publishes international standards for all electrical, electronic, and related technologies. The IEC document 60825-1 outlines the safety of laser products. A description of each class of laser is given below:

Class	Description	Warning Label
1	This class of laser is safe under all conditions of normal use, including use with optical instruments for intrabeam viewing. Lasers in this class do not emit radiation at levels that may cause injury during normal operation, and therefore the maximum permissible exposure (MPE) cannot be exceeded. Class 1 lasers can also include enclosed, high-power lasers where exposure to the radiation is not possible without opening or shutting down the laser.	
1M	Class 1M lasers are safe except when used in conjunction with optical components such as telescopes and microscopes. Lasers belonging to this class emit large-diameter or divergent beams, and the MPE cannot normally be exceeded unless focusing or imaging optics are used to narrow the beam. However, if the beam is refocused, the hazard may be increased and the class may be changed accordingly.	
2	Class 2 lasers, which are limited to 1 mW of visible continuous-wave radiation, are safe because the blink reflex will limit the exposure in the eye to 0.25 seconds. This category only applies to visible radiation (400 - 700 nm).	
2M	Because of the blink reflex, this class of laser is classified as safe as long as the beam is not viewed through optical instruments. This laser class also applies to larger-diameter or diverging laser beams.	
3R	Lasers in this class are considered safe as long as they are handled with restricted beam viewing. The MPE can be exceeded with this class of laser, however, this presents a low risk level to injury. Visible, continuous-wave lasers are limited to 5 mW of output power in this class.	
3B	Class 3B lasers are hazardous to the eye if exposed directly. However, diffuse reflections are not harmful. Safe handling of devices in this class includes wearing protective eyewear where direct viewing of the laser beam may occur. In addition, laser safety signs lightboxes should be used with lasers that require a safety interlock so that the laser cannot be used without the safety light turning on. Class-3B lasers must be equipped with a key switch and a safety interlock.	
4	This class of laser may cause damage to the skin, and also to the eye, even from the viewing of diffuse reflections. These hazards may also apply to indirect or non-specular reflections of the beam, even from apparently matte surfaces. Great care must be taken when handling these lasers. They also represent a fire risk, because they may ignite combustible material. Class 4 lasers must be equipped with a key switch and a safety interlock.	
All class 2 lasers (and higher) must display, in addition to the corresponding sign above, this triangular warning sign		

[Hide SM-Pigtailed Butterfly Package](#)

SM-Pigtailed Butterfly Package

Item #	Info	Wavelength	Power (Typical) ^a	Typical/Max Drive Current	Fiber Pigtail	Monitor Photodiode ^b
FPL785S-250		785 nm	250 mW (Min)	500 mA / 550 mA ^c	1 m, 780HP	Yes









FPL1053S		1310 nm	130 mW	400 mA / 500 mA	1.5 m, SMF-28e+	No
FPL1009S		1550 nm	100 mW	400 mA / 500 mA	1.5 m, SMF-28e+	No
FPL1054S		1625 nm	80 mW	400 mA / 500 mA	1.5 m, SMF-28e+	No
FPL1059S		1650 nm	80 mW	400 mA / 500 mA	1.5 m, SMF-28e+	No
FPL1940S		1940 nm	15 mW	400 mA / 500 mA	1.5 m, SM2000	No
FPL2000S		2000 nm	15 mW	400 mA / 500 mA	1.5 m, SM2000	No

- Each pigtailed laser diode is unique; the specific operating data (i.e., Power, Operating Current, Threshold Current, etc.) is included on a specifications sheet that is shipped with the product.
- Laser diodes with a built-in monitor photodiode can operate at constant power.
- Some FPL785S-250 lasers will produce an output power higher than the 300 mW maximum when driven with a 550 mA current. Do not drive the laser diode with a current that will cause the output power to exceed the specified maximum power rating. Operating in this regime can cause damage to the device.

Part Number	Description	Price	Availability
FPL785S-250	785 nm, 250 mW Min, Butterfly Laser Diode, SM Fiber, FC/APC	\$1,790.00	Today
FPL785S-250	CWL = 783.8 nm, P = 263.2 mW (I = 500 mA), 25 °C	\$1,790.00	3-5 Days
FPL785S-250	CWL = 785.8 nm, P = 250.0 mW (I = 429 mA), 25 °C	\$1,790.00	Today
FPL785S-250	CWL = 785.7 nm, P = 250.0 mW (I = 414 mA), 25 °C	\$1,790.00	Today
FPL785S-250	CWL = 785.6 nm, P = 250.0 mW (I = 418 mA), 25 °C	\$1,790.00	Today
FPL785S-250	CWL = 785.6 nm, P = 250.0 mW (I = 445 mA), 25 °C	\$1,790.00	Today
FPL785S-250	CWL = 785.6 nm, P = 250.0 mW (I = 419 mA), 25 °C	\$1,790.00	Today
FPL785S-250	CWL = 785.7 nm, P = 250.0 mW (I = 441 mA), 25 °C	\$1,790.00	Today
FPL785S-250	CWL = 785.3 nm, P = 250.0 mW (I = 427 mA), 25 °C	\$1,790.00	Today
FPL785S-250	CWL = 785.4 nm, P = 250.0 mW (I = 440 mA), 25 °C	\$1,790.00	3-5 Days
FPL785S-250	CWL = 784.0 nm, P = 250.0 mW (I = 439 mA), 25 °C	\$1,790.00	Today
FPL785S-250	CWL = 785.6 nm, P = 250.0 mW (I = 410 mA), 25 °C	\$1,790.00	Today
FPL1053S	1310 nm, 130 mW, Butterfly Laser, SM Fiber, FC/APC	\$1,270.00	Today
FPL1009S	1550 nm, 100 mW, Butterfly Laser, SM Fiber, FC/APC	\$1,270.00	Today
FPL1054S	1625 nm, 80 mW, Butterfly Laser, SM Fiber, FC/APC	\$1,320.00	3-5 Days
FPL1059S	1650 nm, 80 mW, Butterfly Laser, SM Fiber, FC/APC	\$1,350.00	Today
FPL1940S	1940 nm, 15 mW, Butterfly Laser, SM Fiber, FC/APC	\$3,000.00	Today
FPL2000S	2000 nm, 15 mW, Butterfly Laser, SM Fiber, FC/APC	\$3,500.00	Today

[Hide PM-Pigtailed Butterfly Package](#)

PM-Pigtailed Butterfly Package

Item #	Info	Wavelength	Power (Typical) ^a	Typical/Max Drive Current	Extinction Ratio	Fiber Pigtail	Connector Key Alignment	Monitor Photodiode ^b
BF-915-0180		915 nm	200 mW	340 mA / 390 mA	N/A	1 m, PM980-XP	None	Yes
BF-940-0200		940 nm	200 mW	350 mA / 420 mA	N/A	1 m, PM980-XP	None	Yes
BF-979-0300		975 nm	300 mW	490 mA / 580 mA	N/A	1 m, PM980-XP	None	Yes
BF-1064-0180		1064 nm	180 mW	384 mA / 484 mA	N/A	1 m, Corning PM	None	Yes
FPL1053P		1310 nm	130 mW	400 mA / 500 mA	N/A	1.5 m, Corning PM 13-U25A	Slow Axis	No
FPL1009P		1550 nm	100 mW	400 mA / 500 mA	>18 dB	1.5 m, Corning PM 15-U40A	Slow Axis	No
FPL1009PXL		1550 nm	100 mW (Min)	400 mA / 500 mA	>18 dB	1.5 m, Corning PM 15-U40A	Slow Axis	No
FPL1054P		1625 nm	80 mW	400 mA / 500 mA	N/A	1.5 m, Corning PM 15-U40A	Slow Axis	No
FPL1059P		1650 nm	80 mW	400 mA / 500 mA	N/A	1.5 m, Corning PM 15-U40A	Slow Axis	No

- Each pigtailed laser diode is unique; the specific operating data (i.e., Power, Operating Current, Threshold Current, etc.) is included on a specifications sheet that is shipped with the product.
- Laser diodes with a built-in monitor photodiode can operate at constant power.

Part Number	Description	Price	Availability
BF-915-0180	915 nm, 180 mW, Butterfly Laser Diode, PM Fiber, FC/APC	\$1,882.00 Volume Pricing Available	Lead Time
BF-940-0200	940 nm, 200 mW, Butterfly Laser Diode, PM Fiber, FC/APC	\$1,982.00 Volume Pricing Available	3-5 Days
BF-979-0300	975 nm, 300 mW, Butterfly laser Diode, PM Fiber, FC/APC	\$2,068.00 Volume Pricing Available	Lead Time
BF-1064-0180	1064 nm, 180 mW, Butterfly Laser Diode, PM, FC/APC	\$1,994.00 Volume Pricing Available	Lead Time
FPL1053P	1310 nm, 130 mW, Butterfly Laser, PM Fiber, FC/APC	\$1,402.50	Today
FPL1009P	1550 nm, 100 mW, Butterfly Laser, PM Fiber, FC/APC	\$1,402.50	3-5 Days
FPL1009PXL	1550 nm, 100 mW Min, Butterfly Laser, PM Fiber, FC/APC	\$2,805.00	Today
FPL1054P	1625 nm, 80 mW, Butterfly Laser, PM Fiber, FC/APC	\$1,450.00	Today
FPL1059P	1650 nm, 80 mW, Butterfly Laser, PM Fiber, FC/APC	\$1,475.00	Today

Visit the *Fabry-Perot Laser Diodes, Pigtailed Butterfly Package* page for pricing and availability information:

http://www.thorlabs.com/newgrouppage9.cfm?objectgroup_id=4190

BF-915-0180 - 915 nm, 180 mW, Butterfly Laser Diode, PM Fiber, FC/APC

Specifications

Optical Electrical Characteristics ($T_{CHIP} = 25\text{ }^{\circ}\text{C}$, $P = 200\text{ mW}$)

Characteristic	MIN	TYP	MAX	UNIT
Center Wavelength	910	915	920	nm
Spectral Bandwidth (FWHM)	-	0.5	2.0	nm
Optical Output Power (CW)	-	200	-	mW
Operating Voltage	-	2.1	2.5	V
Operating Current	-	340	390	mA
Threshold Current	-	30	50	mA
Slope Efficiency	0.55	0.63	-	W/A

Absolute Maximum Ratings^a ($T_{CHIP} = 25\text{ }^{\circ}\text{C}$)

Characteristic		
Operating Temperature	-20 to 70	$^{\circ}\text{C}$
Storage Temperature	-40 to 80	$^{\circ}\text{C}$
Lead Soldering Temperature	250	$^{\circ}\text{C}$

- a. Absolute Maximum Rating specifications should never be exceeded. Operating beyond these conditions can seriously damage the laser. For more information, please see the [Laser Diode Tutorial](#).

TEC Operation (Typ./Max @ $T_{CASE} = 25\text{ }^{\circ}\text{C}/75\text{ }^{\circ}\text{C}$)

Characteristic	MIN	TYP	MAX	UNIT
TEC Current	-	-	2.0	A
TEC Voltage	-	-	3.2	V

Fiber Specs

Fiber Specifications	
Characteristic	
Fiber Type	PM980-XP
Core Diameter	N/A
Mode Field Diameter ^a	6.6 ± 0.7 μm at 980 nm
Numerical Aperture	0.12
Fiber Length	1 m
Connector	FC/APC, 2.0 mm Narrow Key

a. Mode Field Diameter (MFD) is specified as a nominal value.

Drawings

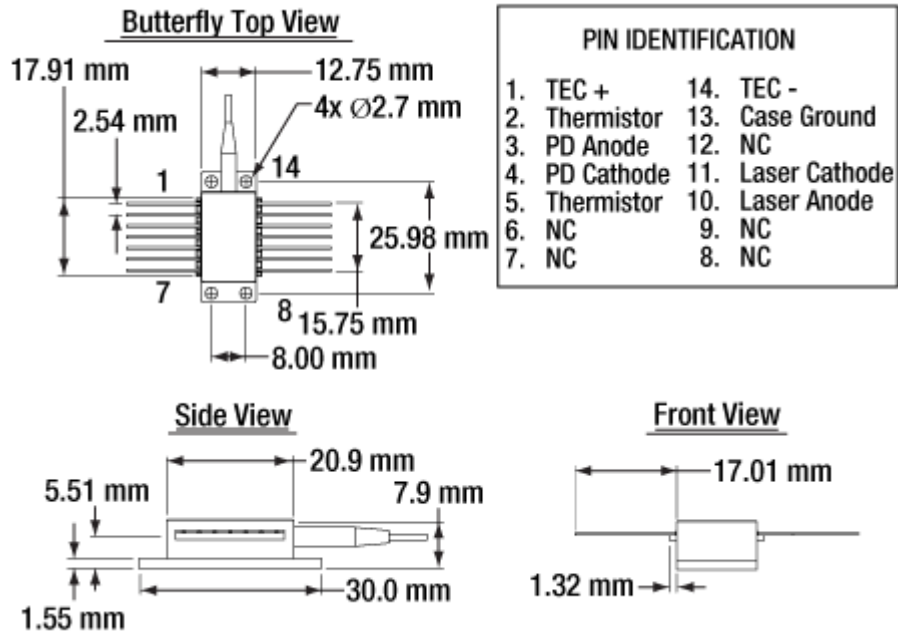

BF-915-0180 - 915 nm, 180 mW, Butterfly Laser Diode, PM Fiber, FC/APC